

# Pressure Gauge Sealing Washers

Model 910.17

## Accessories, Mechanical

### WIKAI sealing rings

As is generally known, the use of flat sealing washers of soft or nonferrous metals for pressure gauges, valves and other fittings is often problematic. The screwed connections have to be tight, and simultaneously the parts that are to be connected have to be in a specific position to each other.

The problem is that either the pressure gauge or valve does not have the desired reading or operation position, or in the ideal position to seal effectively.

Consequently, it becomes necessary to unscrew out and replace flat sealing washers by washers with different thicknesses several times, until the desired sealing quality is achieved.

With the WIKAI sealing ring it is possible to orientate the pressure gauge to the desired position by turning up to a full turn after sealing has been made with approximately  $\frac{1}{4}$  turn after contact with the sealing ring.

Due to its slightly different form and the higher strength of its material, the WIKAI stainless steel (CrNi) sealing add-ring enables the achievement of an excellent sealing quality after only a slight turn, but only approx.  $\frac{1}{2}$  further turn is possible for orientation in this material.

#### Available are two versions:

**Form 1:** For self-centering by centering spigot in accordance with EN 837-1.

**Form 2:** For centering in the bore hole, intended for pressure gauge connectors not featuring a spigot or sealing shoulder.

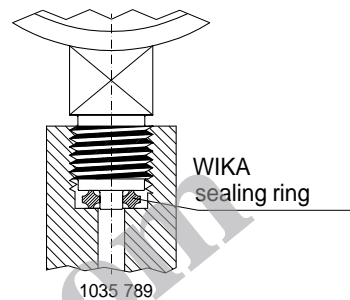

#### Mounting examples

##### Form 1

centering with spigot

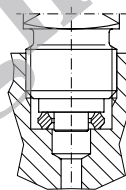

1268 201

##### Form 2

centering in bore

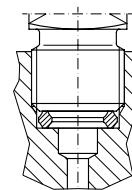

1268 210

#### Dimensions

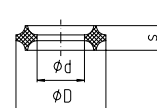

1035 797

Design	Thread size	Material	Dimensions [mm] ca.			Form	Product-No.
			D + 0.2	d - 0.2	s		
	G $\frac{1}{8}$	Cu	8 + 0.1	4.3 + 0.1	2.7	1	90 90789
	G $\frac{1}{4}$ , M 12 x 1.5	Al	9.4	5.4	3.2		90 90797
	G $\frac{1}{4}$ , M 12 x 1.5	Cu	9.4	5.4	3.2		90 90800
	G $\frac{1}{4}$ , M 12 x 1.5	1.4571	9.4	5.4	3.2		90 92161
	G $\frac{3}{8}$ , G $\frac{1}{2}$ , M 20 x 1.5	Cu	14.8	8	4.2		90 90819
	G $\frac{3}{8}$ , G $\frac{1}{2}$ , M 20 x 1.5	1.4571	14.8	8	4.2		90 92099
	G $\frac{1}{4}$	Al	11	5.5	3.2	2	90 92269
	G $\frac{1}{4}$	Cu	11	5.5	3.2		90 92277
	M 12 x 1.5	Cu	10	5.5	3.2		90 92285
	G $\frac{1}{2}$	Cu	18.4	11	4.2		90 92293

## Sealing washers per EN 837-1 (and similar design)

These sealing washers are intended to seal connections of pressure gauges and suitable pipe fittings. The dimensions of the sealing washers comply with the standard EN 837-1 for connections. Available are washers of copper (Cu), nickel (Ni), asbestos-free material Novapress 300 (NP uni) and PTFE.

The PTFE washer with a thickness of 0.5 mm is primarily intended to suit diaphragm gauges with threaded connections, the wetted parts of which are protected against aggressive media by a PTFE lining. With metal washers there is a risk of the PTFE lining being damaged.

The PTFE washer with a thickness of 2.0 mm is mainly intended to suit pressure gauges and chemical seals used for the food industry, where in general the wetted parts are of stainless steel (CrNi).

## Dimensions

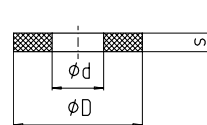

1035 800

Design	Thread size	Material	Dimensions [mm] ca.			Product-no.
	G ¼ *)	Cu	9.5	5.2	1.5	90 91424
	G ¼ *)	NP uni	9.5	5.2	1.5	90 91432
	G ½ *)	Cu	17.5	6.2	2	90 91440
	G ½	NP uni	17.5	6.2	2.5	90 91459
	G ½ *)	Ni	17.5	6.2	2	90 91467
	G ¼	PTFE	9.5	5.2	0.5	90 92080
	G ½	PTFE	17.5	6.2	0.5	90 91173
	G ½	PTFE	17.5	7	2	90 91505

\*) per EN 837-1

## Special sealing rings

To fit pressure gauges with lens-seal-type connector G ¼ B (e.g. in combination with flange No. 9091165 as per Data Sheet AM 09.05) a lens-type sealing ring as per EN 837-1 is available.

## Dimensions

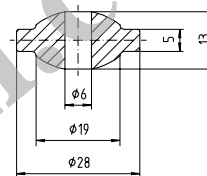

1270 249

Design	Thread size	Material	Dimensions	Product-no.
Lenstype	G ¼	St	EN 837-1	9091483

## Double-edge type bulkhead sealing rings

These sealing rings are included for replacement purposes and intended for flareless tube fittings and bulkhead fittings where the seal is made underneath the spanner hexagon of the fitting. Normally, appropriate sealing rings are originally supplied with the fitting.

## Dimensions

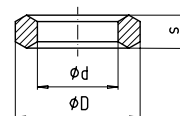

1268 198

Design	Thread size	Material	Dimensions [mm] ca.			Product no.
	G ¼	St	11.3	6	4.5	909223-4
	G ½	St	18.5	12	5	909224-2
	G ½	1.4571	18.5	12	5	909225-

## Ordering information

For the ordering the indication of the 7-digit ordering number is sufficient. Options are to be indicated additionally.

Specifications and dimensions given in this leaflet represent the state of engineering at the time of printing. Modifications may take place and materials specified may be replaced by others without prior notice.



**WIKAI Alexander Wiegand GmbH & Co. KG**  
 Alexander-Wiegand-Straße · 63911 Klingenberg  
 ☎ (0 9372) 132-0 · ☎ (0 9372) 132-406/414  
 http://www.wika.de · E-mail: info@wika.de